

CONTINUOUS GEARED ALUMINUM HINGES



PEMKO continuous hinges are manufactured of extruded 3063-T6 aluminum alloy / temper and consist of three interlocking extrusions in a pinless assembly. These hinges have been certified functional after testing per ANSI 156.1 over 1,500,000 cycles with a Standard Duty, full-mortise hinge and a 150 lb door. UL-Fire rating is 90 minutes.

Other features:

- U.L. and U.L.C. listed
- 20% more aluminum at stress points
- Anodized after milling and drilling
- Concealed thrust bearings
- Templated fastener pattern
- Full door / frame height
- No mortising
- No door sagging or binding
- Ideal for heavy doors
- Non-handed
- Installation instructions

Full-Mortise Applications

1. **New Construction:**
 - a. New door and frame
2. **Renovation:**
 - a. New door and frame
 - b. New door with existing frame
 - c. Existing door with new frame

Note: The mortise hinge will cover the existing butt hinge preps.

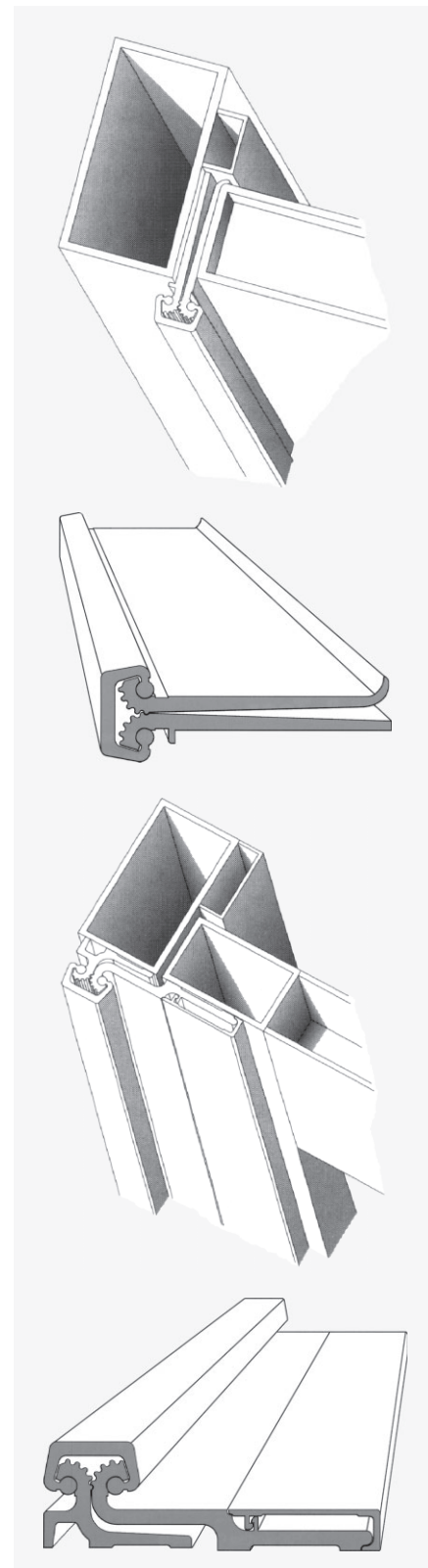

Full-Surface Applications

1. **New Construction:**
 - a. New door and frame
2. **Renovation:**
 - a. New door and frame
 - b. New door with existing frame
 - c. Existing door with new frame
 - d. Where door must swing completely out of the frame opening
3. **Retrofit:**
 - a. Existing door and frame
 - b. New door and existing frame
 - c. Existing door with new frame
 - d. Where door must swing completely out of the frame opening

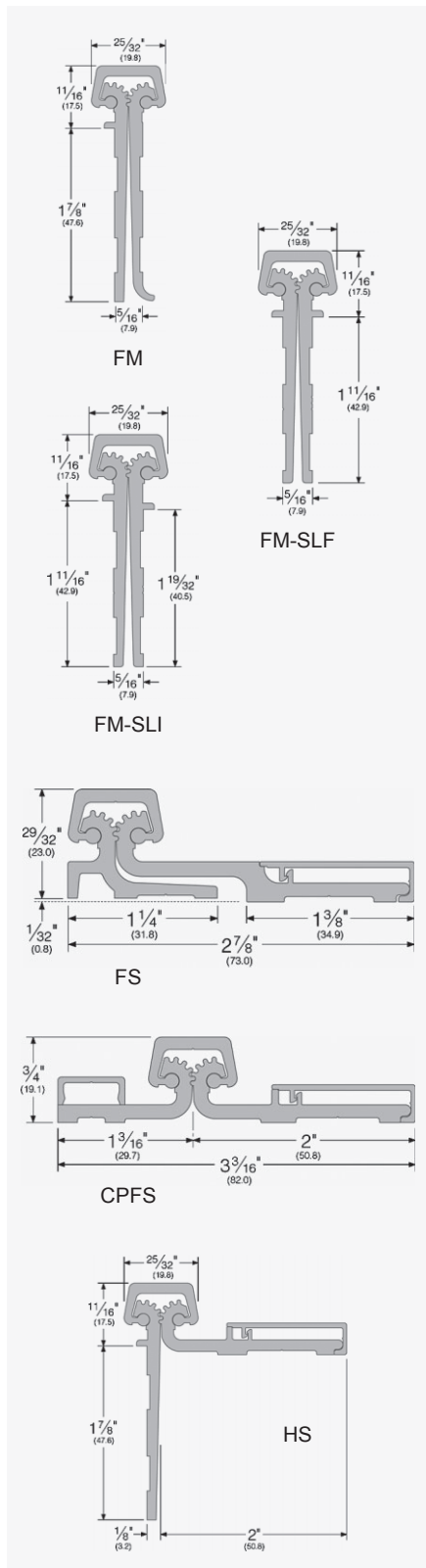

CONTINUOUS GEARED ALUMINUM HINGES



MODEL No.	LENGTH	DESCRIPTION	FINISH		
FULL-MORTISE PEMKO HINGES					
FM83	83"	Standard Duty	C20D , C28	Incl. (1)	5 Individ. pckgd.
FM83HD	83"	Heavy Duty	C20D , C28	Incl. (1)	5 Individ. pckgd.
FM95HD	95"	Heavy Duty	C20D , C28	Incl. (1)	5 Individ. pckgd.
FULL-MORTISE PEMKO HINGES with short leaf flush					
FM83SLF	83"	Standard Duty	C20D , C28	Incl. (1)	5 Individ. pckgd.
FM83SLFHD	83"	Heavy Duty	C20D , C28	Incl. (1)	5 Individ. pckgd.
FM95SLFHD	95"	Heavy Duty	C20D , C28	Incl. (1)	5 Individ. pckgd.
FULL-MORTISE PEMKO HINGES with short leaf flush inset					
FM83SLI	83"	Standard Duty	C20D , C28	Incl. (1)	5 Individ. pckgd.
FM83SLIHD	83"	Heavy Duty	C20D , C28	Incl. (1)	5 Individ. pckgd.
FM95SLI	95"	Standard Duty	C20D , C28	Incl. (1)	5 Individ. pckgd.
FM95SLIHD	95"	Heavy Duty	C20D , C28	Incl. (1)	5 Individ. pckgd.
FULL-SURFACE PEMKO HINGES					
FS83	83"	Standard Duty	C20D , C28	Incl. (2)	5 Individ. pckgd.
FS83HD	83"	Heavy Duty	C20D , C28	Incl. (2)	5 Individ. pckgd.
FS95	95"	Standard Duty	C20D , C28	Incl. (2)	5 Individ. pckgd.
FS95HD	95"	Heavy Duty	C28	Incl. (2)	5 Individ. pckgd.
FULL-SURFACE CENTER PIVOT PEMKO HINGES					
CPFS83	83"	Standard Duty	C20D , C28	Incl. (2)	5 Individ. pckgd.
HALF-SURFACE PEMKO HINGES					
HS83	83"	Standard Duty	C20D , C28	Incl. (2)	5 Individ. pckgd.

HALF-MORTISE PEMKO HINGES FOR SPECIAL APPLICATIONS are available on request.

(1) Fasteners for frame portion:

- 12 ea. No. 12-24 C x 7/16" FHUC self-cutting screws

Fasteners for door portion:

- 8 ea. Thru-bolts with 1/4-20 thread 1-5/8" long, shallow head
- 8 ea. Shoulder bolts with 1/4-20 thread 1" long, pancake hex head
- 4 ea. No. 12 x 3/4" self-tapping screws

(2) Fasteners for both portions:

- 20 ea. No. 12-24 C x 7/16" FHUC self-cutting screws

WOOD SCREWS for frame or door or both will be furnished on request only (specify on order).

Cross-Reference information for "like products with similar profiles and applications" is available.